

HD 152 · HD 172

In-line mounting · Operating pressure up to 630 bar / 9137 psi · Nominal flow rate up to 190 l/min / 50.2 gpm

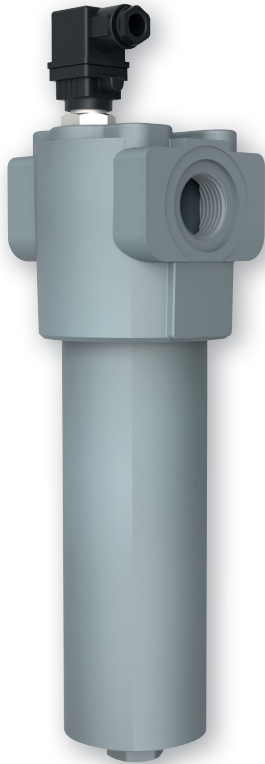

High Pressure Filter HD 172

Description

Application

In the high pressure circuits of hydraulic systems.

Performance features

Protection against wear:

By means of filter elements that even in full-flow filtration meet the highest demands regarding cleanliness classes.

Protection against malfunction:

Through installation near to the control valves or other expensive components. The specific determined flow rate guarantees a closed by-pass valve even at $v \leq 200 \text{ mm}^2/\text{s}$ / 927 SUS (cold start condition).

Filter elements

Flow direction from outside to center.

The star-shaped pleating of the filter material results in:

- › large filter surfaces
- › low pressure drop
- › high dirt-holding capacities
- › long service life

Filter maintenance

By using a clogging indicator the correct moment for maintenance is stated and guarantees the optimum utilization of the filter life.

Materials

Filter head:	Spheroidal graphite cast iron (SGI)
Filter bowl:	Cold extruded steel
Coating:	Powder paint
Seals:	NBR (FPM on request)
Filter media:	EXAPOR®MAX 2 - inorganic multi-layer microfiber web
	Paper - cellulose web, impregnated with resin

Accessories

Electrical and / or optical clogging indicators are available on request. Dimensions and technical data see catalog sheet 60.40.

Operating pressure

0 ... 400 bar / 5800 psi, min. 2×10^6 pressure cycles
Nominal pressure according to DIN 24550

0 ... 630 bar / 9137 psi, min. 10^4 pressure cycles
Quasi-static operating pressure

Permissible pressures for other numbers of cycles

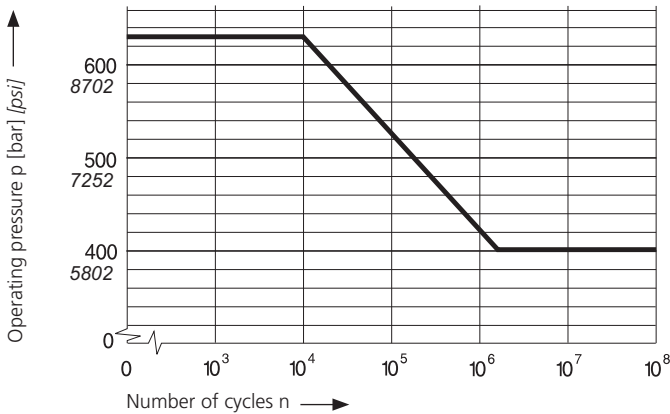

Nominal flow rate

Up to 190 l/min / 47.6 gpm (see Selection Chart, column 2)
The nominal flow rates indicated by ARGO-HYTOS are based on the following features:

- › closed by-pass valve at $v \leq 200 \text{ mm}^2/\text{s}$ / 927 SUS
- › element service life > 1000 operating hours at an average fluid contamination of 0.07 g per l/min / 0.27 g per gpm flow volume
- › flow velocity in the connection lines:
up to 250 bar $\leq 8 \text{ m/s}$ / up to 3626 psi $\leq 26.3 \text{ ft/s}$
> 250 bar $\leq 12 \text{ m/s}$ / > 3626 psi $\leq 39.4 \text{ ft/s}$

Filter fineness

5 $\mu\text{m(c)}$... 30 $\mu\text{m(c)}$
 β -values according to ISO 16889
(see Selection Chart, column 4 and diagram Dx).

Dirt-holding capacity

Values in g test dust ISO MTD according to ISO 16889
(see Selection Chart, column 5).

Hydraulic fluids

Mineral oil and biodegradable fluids
(HEES and HETG, see info-sheet 00.20).

Temperature range

-30 °C ... +100 °C (temporary -40 °C ... +120 °C)
-22 °F ... +212 °F (temporary -40 °F ... +248 °F)

Viscosity at nominal flow rate

- › at operating temperature: $v < 60 \text{ mm}^2/\text{s}$ / 280 SUS
- › as starting viscosity: $v_{\text{max}} = 1200 \text{ mm}^2/\text{s}$ / 5560 SUS
- › at initial operation:
The recommended starting viscosity can be read from the diagram D (pressure drop as a function of the kinematic viscosity) as follows: Find the 70% Δp of the cracking pressure of the by-pass valve on the vertical axis. Draw a horizontal line so that it intersects the Δp curve at a point. Read this point on the horizontal axis for the viscosity.

Mounting position

Preferably vertical, filter head on top.

Connection

Threaded ports according to

- › ISO 228 or DIN 13
- › SAE standard J514

Sizes see Selection Chart, column 6
(other port threads on request).

Δp-curves for complete filters in Selection Chart, column 3

D1 Pressure drop as a function of the **flow volume** at $v = 35 \text{ mm}^2/\text{s}$ / 162 SUS (0 = casing empty)

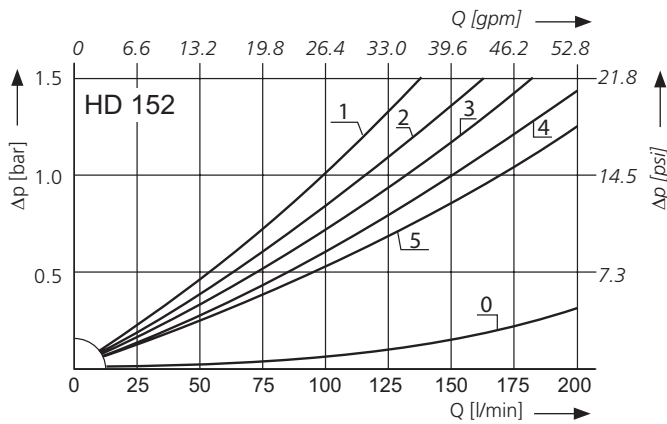

Pressure drop as a function of the **kinematic viscosity** at nominal flow

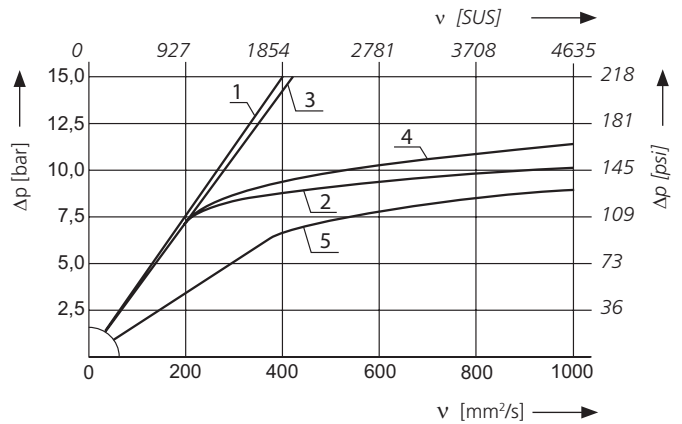

D1 Pressure drop as a function of the **flow volume** at $v = 35 \text{ mm}^2/\text{s}$ / 162 SUS (0 = casing empty)

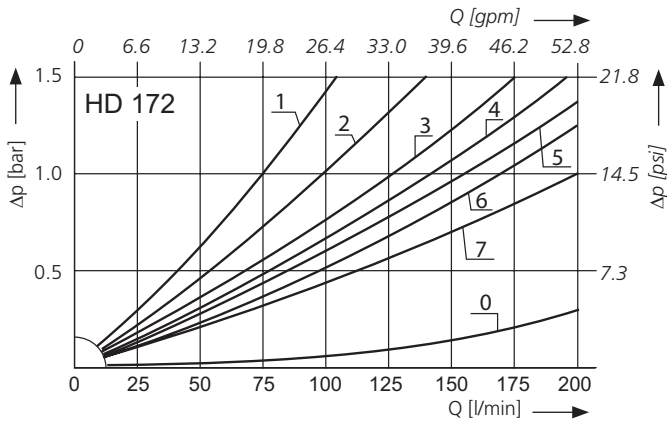

Pressure drop as a function of the **kinematic viscosity** at nominal flow

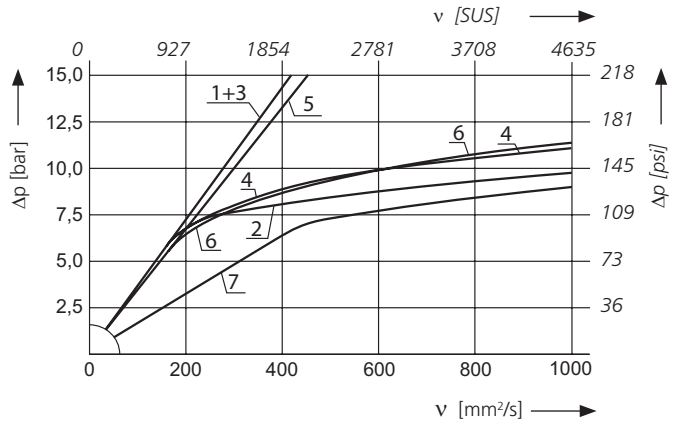

Filter fineness curves in Selection Chart, column 4

Dx Filtration ratio β as a function of particle size x obtained by the Multi-Pass Test according to ISO 16889

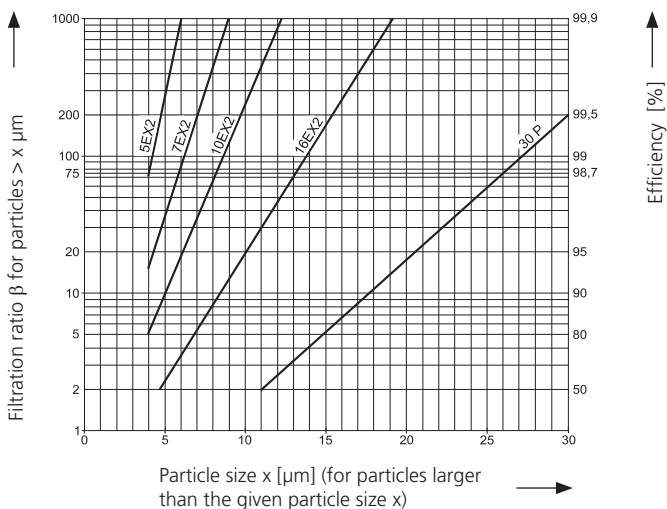

The abbreviations represent the following β -values resp. finenesses:

For EXAPOR®MAX2 and Paper elements:

- 5EX2 = $\bar{\beta}_{5(c)}$ = 200 EXAPOR®MAX 2
- 7EX2 = $\bar{\beta}_{7(c)}$ = 200 EXAPOR®MAX 2
- 10EX2 = $\bar{\beta}_{10(c)}$ = 200 EXAPOR®MAX 2
- 16EX2 = $\bar{\beta}_{16(c)}$ = 200 EXAPOR®MAX 2
- 30P = $\bar{\beta}_{30(c)}$ = 200 Paper

Based on the structure of the filter media of the 30P paper elements, deviations from the printed curves are quite probable.

For screen elements

- 40S = screen material with mesh size 40 μm
 - 60S = screen material with mesh size 60 μm
 - 100S = screen material with mesh size 100 μm
- Tolerances for mesh size according to DIN 4189

For special applications, finenesses differing from these curves are also available by using special composed filter media.

Selection Chart

Part No.	Nominal flow rate	Pressure drop see diagram D1/curve no.	Filter fineness see diagram D1/curve no.	Dirt-holding capacity	Connection A/B	Cracking pressure of by-pass	Symbol	Replacement filter element Part No.	Weight	Clogging indicator	Cracking pressure in ()	Remarks
1	l/min	3	4	g	bar	8	9	10	kg	bar	11	12
HD 152-186 ED8	110	D1/1	10EX2	13	G $\frac{3}{4}$	-	4	V3.0617-26 ²	7.1	electrical	(5)	change-over
HD 152-166¹	125	D1/2	10EX2	17	G $\frac{3}{4}$	7	1	V3.0617-06	6.9	-	-	-
HD 152-188 ED8	150	D1/3	16EX2	14	G1	-	4	V3.0617-18 ²	7.1	electrical	(5)	change-over
HD 152-168¹	175	D1/4	16EX2	17	G1	7	1	V3.0617-08	6.9	-	-	-
HD 152-151	130	D1/5	30P	8,7	G1	7	1	P3.0617-01 ³	6.9	-	-	-
HD 172-189 ED8	80	D2/1	5EX2	16	G1	-	4	V3.0623-13 ²	8.4	electrical	(5)	change-over
HD 172-163	110	D2/2	5EX2	17	G1	7	1	V3.0623-03	8.0	-	-	-
HD 172-186 ED8	140	D2/3	10EX2	18	G1	-	4	V3.0623-26 ²	8.4	electrical	(5)	change-over
HD 172-166¹	160	D2/4	10EX2	23	G1	7	1	V3.0623-06	8.0	-	-	-
HD 172-188 ED8	180	D2/5	16EX2	19	G1	-	4	V3.0623-18 ²	8.4	electrical	(5)	change-over
HD 172-168¹	190	D2/6	16EX2	25	G1	7	1	V3.0623-08	8.0	-	-	-
HD 172-151	150	D2/7	30P	14	G1	7	1	P3.0623-11 ³	8.0	-	-	-

¹ Preferred type, no minimum order quantity required

² Filter element differential pressure stable up to 160 bar, clogging indicator required

³ Paper media supported with metal gauze

Optical or electrical clogging indicators are available to monitor the clogging condition of the element. When ordering filters with integrated monitoring, the abbreviation of the clogging indicator has to be added to the order code of the desired filter variant.

For the appropriate clogging indicator see catalog sheet 60.40.

Order example: The filter HD 152-166 is to be supplied with an optical indicator with automatic reset.

Order code:

HD 152-166 OD1

Part No. (basic unit)

Clogging indicator

Remarks:

- › The switching pressure of the clogging indicator has always to be lower than the cracking pressure of the by-pass valve (see Selection Chart, column 7).
- › For versions with electrical clogging indicator, the device socket is not included in the scope of delivery.
- › For the electrical clogging indicator of type DIN EN 175301-803 (ED8 and ED9), a device socket with two LEDs is available, which additionally enables visual indication of the filter contamination (order no. DG 041.1200).
- › The filters listed in this chart are standard filters. Other designs available on request.

Selection Chart

Part No.	Nominal flow rate gpm	Pressure drop see diagram D1/curve no.	Filter fineness see diagram D1/curve no.	Dirt-holding capacity g	Connection A/B	Cracking pressure of by-pass SAE	Symbol	Replacement filter element Part No.	Weight lbs	Clogging indicator Cracking pressure in () psi	Remarks
1	2	3	4	5	6	7	8	9	10	11	12
HD 152-786 ED8	29.1	D1/1	10EX2	13	-12 ⁴	-	4	V3.0617-26 ²	15.7	electrical (73)	change-over
HD 152-766¹	33.0	D1/2	10EX2	17	-12 ⁴	102	1	V3.0617-06	15.2	-	-
HD 152-788 ED8	39.6	D1/3	16EX2	14	-16 ⁵	-	4	V3.0617-18 ²	15.7	electrical (73)	change-over
HD 152-768¹	46.2	D1/4	16EX2	17	-16 ⁵	102	1	V3.0617-08	15.2	-	-
HD 152-871	34.3	D1/5	30P	8.7	-16 ⁵	102	1	P3.0617-01 ³	15.2	-	-
HD 172-789 ED8	21.1	D2/1	5EX2	16	-16 ⁵	-	4	V3.0623-13 ²	18.5	electrical (73)	change-over
HD 172-763	29.1	D2/2	5EX2	17	-16 ⁵	102	1	V3.0623-03	17.6	-	-
HD 172-786 ED8	37.0	D2/3	10EX2	18	-16 ⁵	-	4	V3.0623-26 ²	18.5	electrical (73)	change-over
HD 172-766¹	42.3	D2/4	10EX2	23	-16 ⁵	102	1	V3.0623-06	17.6	-	-
HD 172-788 ED8	47.6	D2/5	16EX2	19	-16 ⁵	-	4	V3.0623-18 ²	18.5	electrical (73)	change-over
HD 172-768¹	50.2	D2/6	16EX2	25	-16 ⁵	102	1	V3.0623-08	17.6	-	-
HD 172-761	39.6	D2/7	30P	14	-16 ⁵	102	1	P3.0623-11 ³	17.6	-	-

¹ Preferred type, no minimum order quantity required

² Filter element differential pressure stable up to 2320 psi, clogging indicator required

³ Paper media supported with metal gauze

⁴ Corresponds to 1¹/₁₆-12 UN-2B

⁵ Corresponds to 1⁵/₁₆-12 UN-2B

Optical or electrical clogging indicators are available to monitor the clogging condition of the element. When ordering filters with integrated monitoring, the abbreviation of the clogging indicator has to be added to the order code of the desired filter variant.

For the appropriate clogging indicator see catalog sheet 60.40.

Order example: The filter HD 152-766 is to be supplied with an optical indicator with automatic reset.

Order code: HD 152-766 OD1

Part No. (basic unit) _____

Clogging indicator _____

Remarks:

- › The switching pressure of the clogging indicator has always to be lower than the cracking pressure of the by-pass valve (see Selection Chart, column 7).
- › For versions with electrical clogging indicator, the device socket is not included in the scope of delivery.
- › For the electrical clogging indicator of type DIN EN 175301-803, a device socket with two LEDs is available, which additionally enables visual indication of the filter contamination (order no. DG 041.1200).
- › The filters listed in this chart are standard filters. Other designs available on request.

Dimensions

Version with integrated optical clogging indicator OD1

Version with integrated electrical clogging indicator ED8 with device socket ¹

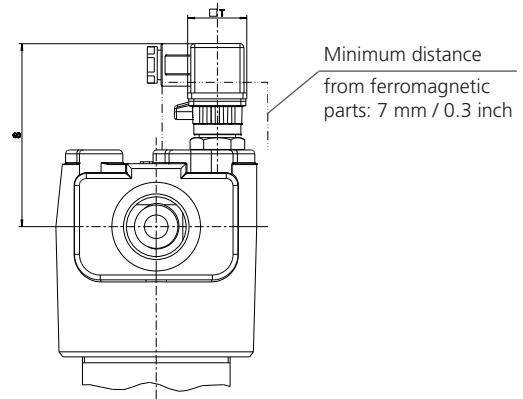
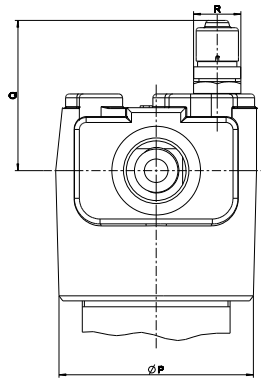
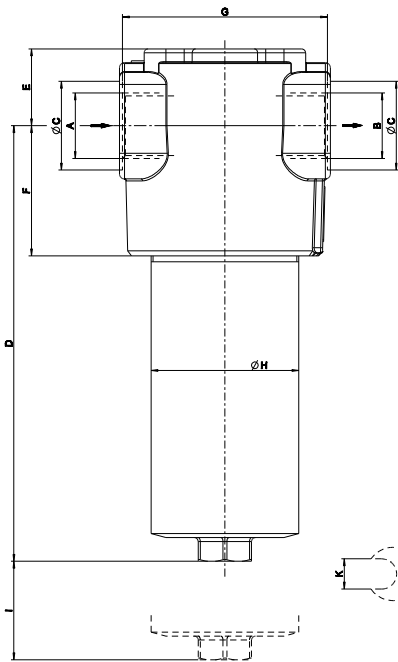

¹ not included in scope of delivery

Terminal connection ED8

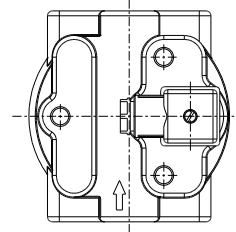
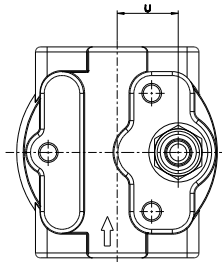
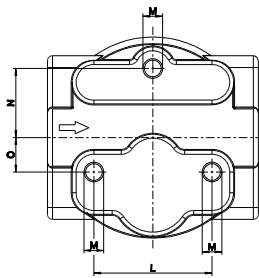
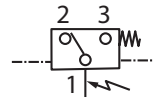

Measurements in mm

Type	A/B	C	D	E	F	G	H	I	K	L	M Ø / depth	N	O	P	Q	R	S	T	U
HD 152	G ^{3/4} , G1	36 / 45	222	39	66	104	75	70	AF 27	60	M10 / 12	35	17.5	99	77	AF 24	93	□ 30	31
HD 172	G1	45	286	39	66	104	75	70	AF 27	60	M10 / 12	35	17.5	99	77	AF 24	93	□ 30	31

Measurements in inch

Type	A/B SAE	C	D	E	F	G	H	I	K mm	L	M Ø / depth	N	O	P
HD 152	-12 / -16	1.42 / 1.77	8.74	1.54	2.60	4.09	2.95	2.76	AF 27	2.36	²	1.38	0.71	3.90
HD 172	-16	1.77	11.26	1.54	2.60	4.09	2.95	2.76	AF 27	2.36	²	1.38	0.71	3.90

Type	Q	R mm	S	T mm	U
HD 152	3.03	AF 24	3.66	□ 1.18	1.22
HD 172	3.03	AF 24	3.66	□ 1.18	1.22

² ³/₈-16 UNC-2B / 0.47

Symbols

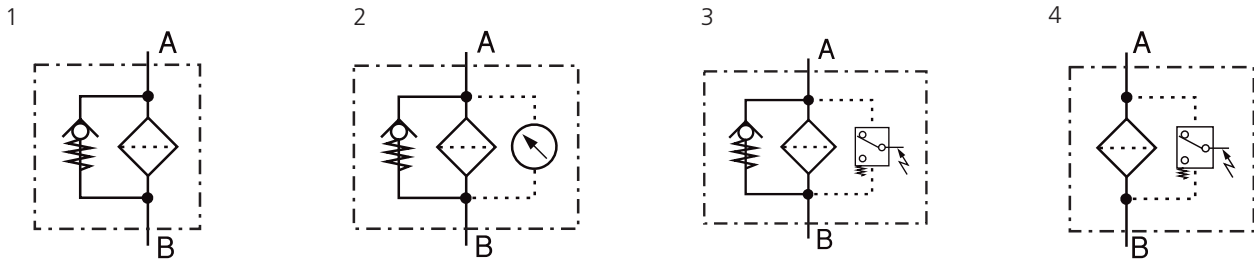

Spare Parts

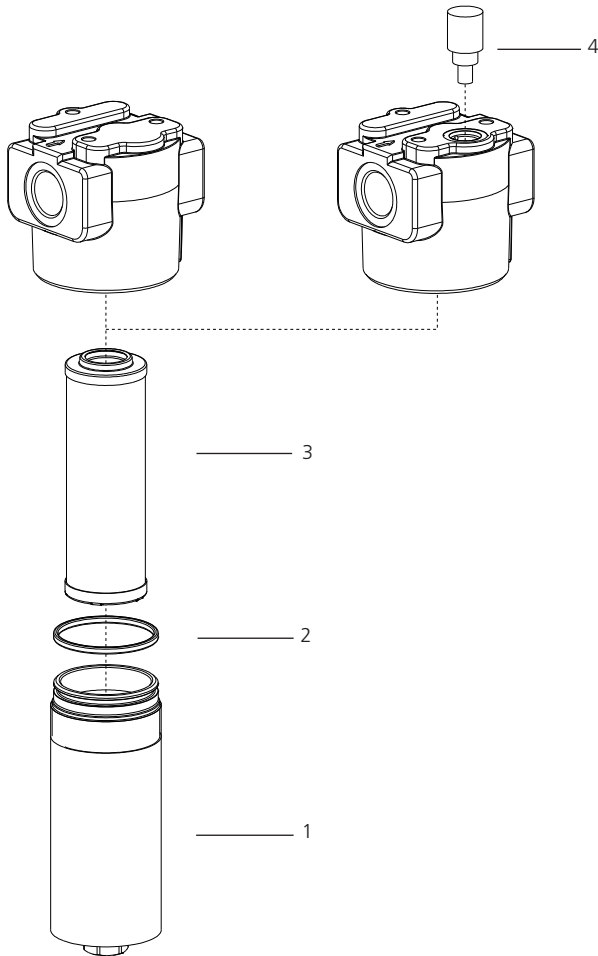

Pos.	Designation	Part No.
1	Filter bowl HD 152	HD 152.0102
1	Filter bowl HD 172	HD 171.0102
2	O-ring 63 x 3.5 mm 2.48 x 0.14 inch	N007.0634
3	Replacement filter element	see Chart/col. 9
4	Clogging indicator	see catalog sheet 60.40

The functions of the complete filters as well as the outstanding features of the filter elements assured by ARGO-HYTOS can only be guaranteed if original ARGO-HYTOS spare parts are used.

Quality Assurance

Quality management according to DIN EN ISO 9001

To ensure constant quality in production and operation, ARGO-HYTOS filter elements undergo strict controls and tests according to the following ISO standards:

ISO 2941	Verification of collapse/burst pressure rating
ISO 2942	Verification of fabrication integrity (Bubble Point Test)
ISO 2943	Verification of material compatibility with fluids
ISO 3968	Evaluation of pressure drop versus flow characteristics
ISO 16889	Multi-Pass-Test (evaluation of filter fineness and dirt-holding capacity)
ISO 23181	Determination of resistance to flow fatigue using high viscosity fluid

Before release into the series production the filter casing is tested for fatigue strength in our pressure pulse test rig. Various quality controls during the production process guarantee the leakfree function and solidity of our filters.

Illustrations may sometimes differ from the original. ARGO-HYTOS is not responsible for any unintentional mistake in this specification sheet.