



Technical Information
Orbital Motors
OML and OMM



Revision History*Table of Revisions*

Date	Changed	Rev
Feb 2014	Converted to Danfoss layout - DITA CMS	BA
Nov 2012	Planetary Gears deleted	AI
Oct 2011	Dimensions added to drawing	AH
May 2011	Typos	AG
Sep 2010	New back page	AF
Mar 2010	Japan location	AE
Jul 2008	Text	AC
Apr 2008	Pictures, drawings and text	AB

Contents
A wide range of Orbital Motors

Characteristic, features and application areas of Orbital Motors.....	5
Characteristic features of Danfoss Orbital Motors.....	5
Technical features of Danfoss Orbital Motor.....	5
The Danfoss Orbital Motors are used in the following application areas:.....	6
Survey of literature with technical data on Danfoss Orbital Motors.....	6

Speed, torque and output

Speed, torque and output.....	7
-------------------------------	---

OML
Versions

OML versions.....	9
Code numbers.....	9
Ordering.....	9

Technical data

Technical data for OML with 16 mm and 5/8 in cylindrical shaft.....	10
---	----

Shaft seal

Max. permissible shaft seal pressure.....	11
---	----

Oil flow

Direction of shaft rotation.....	12
----------------------------------	----

Shaft load

Permissible shaft loads for OML.....	13
--------------------------------------	----

Function diagrams

Function diagrams.....	14
OML 8 function diagram.....	14
OML 12.5 function diagram.....	15
OML 20 function diagram.....	15
OML 32 function diagram.....	16

Shaft

Shaft version.....	17
--------------------	----

Port

Port thread versions.....	18
---------------------------	----

Dimensions, OML end port, European version

OML end port, European version.....	19
Weight and dimensions.....	19

Dimensions, OML end port, US version

OML end port, US version.....	21
Weight and dimensions.....	21

OMM
Versions

OMM versions.....	24
Code numbers.....	24
Ordering.....	24

Technical data

Technical data for OMM with 16 mm and 5/8 in cylindrical shaft.....	25
---	----

Shaft seal

Max. permissible shaft seal pressure.....	26
---	----

Oil flow

Direction of shaft rotation.....	27
----------------------------------	----

Contents**Shaft load**

Permissible shaft loads for OMM.....	28
--------------------------------------	----

Function diagrams

Function diagrams.....	29
OMM 8 function diagram.....	29
OMM 12.5 function diagram.....	29
OMM 20 function diagram.....	30
OMM 32 function diagram.....	30
OMM 50 function diagram.....	31

Shaft

Shaft version.....	32
--------------------	----

Port

Port thread versions.....	33
---------------------------	----

Dimensions, OMM end port, European version

OMM end port, European version.....	34
Weight and dimensions.....	35

Dimensions, OMM end port, US version

OMM end port, US version.....	36
Weight and dimensions.....	37

Dimensions, OMM side port, European version

OMM side port, European version.....	38
Weight and dimensions.....	39

Dimensions, OMM side port, US version

OMM side port, US version.....	40
Weight and dimensions.....	41

Accessories

2 bolt flange kit, code no. 151G0211.....	42
---	----

Hydraulic systems

Installation of the Danfoss Orbital Motors.....	43
About the design.....	43
About the assembly.....	43
Starting up and running in the hydraulic system.....	43
Operation.....	43
Maintenance.....	44

A wide range of Orbital Motors

Characteristic, features and application areas of Orbital Motors

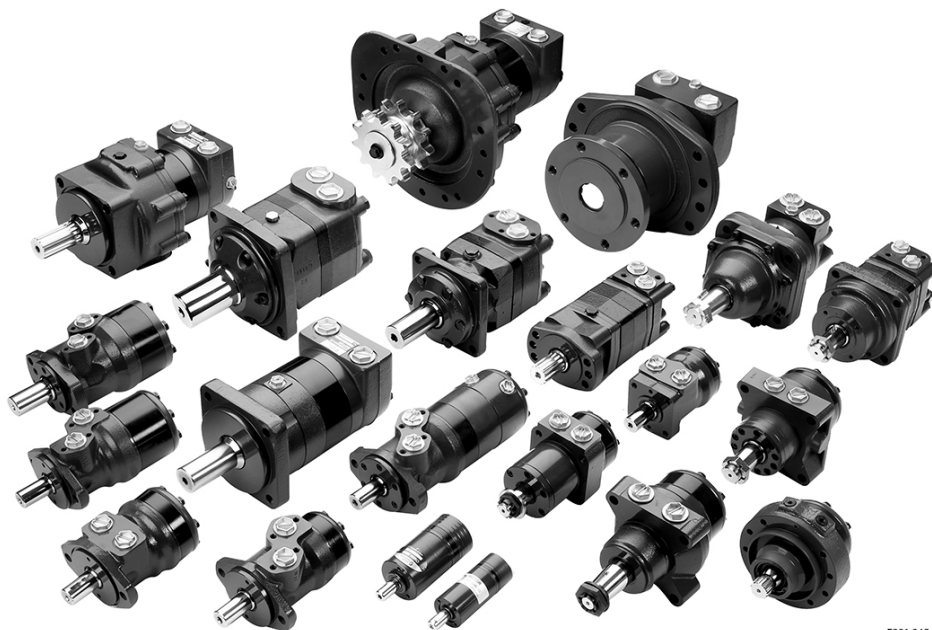

F301 245

Danfoss is a world leader within production of low speed orbital motors with high torque. We can offer more than 3000 different orbital motors, categorised in types, variants and sizes (incl. different shaft versions).

The motors vary in size (rated displacement) from 8 cm³ [0.50 in³] to 800 cm³ [48.9 in³] per revolution.

Speeds range up to approx. 2500 min⁻¹ (rpm) for the smallest type and up to approx. 600 min⁻¹ (rpm) for the largest type.

Maximum operating torques vary from 13 N•m [115 lbf•in] to 2700 N•m [24.000 lbf•in] (peak) and maximum outputs are from 2.0 kW [2.7 hp] to 70 kW [95 hp].

Characteristic features of Danfoss Orbital Motors

- Smooth running over the entire speed range
- Constant operating torque over a wide speed range
- High starting torque
- High return pressure without the use of drain line (High pressure shaft seal)
- High efficiency
- Long life under extreme operating conditions
- Robust and compact design
- High radial and axial bearing capacity
- For applications in both open and closed loop hydraulic systems
- Suitable for a wide variety of hydraulics fluids

Technical features of Danfoss Orbital Motor

The programme is characterised by technical features appealing to a large number of applications and a part of the programme is characterised by motors that can be adapted to a given application. Adaptions comprise the following variants among others:

A wide range of Orbital Motors

- Motors with corrosion resistant parts
- Wheel motors with recessed mounting flange
- OMP, OMR- motors with needle bearing
- OMR motor in low leakage version
- OMR motors in a super low leakage version
- Short motors without bearings
- Ultra short motors
- Motors with integrated positive holding brake
- Motors with integrated negative holding brake
- Motors with integrated flushing valve
- Motors with speed sensor
- Motors with tacho connection
- All motors are available with black finish paint

The Danfoss Orbital Motors are used in the following application areas:

- Construction equipment
- Agricultural equipment
- Material handling & Lifting equipment
- Forestry equipment
- Lawn and turf equipment
- Special purpose
- Machine tools and stationary equipment
- Marine equipment

Survey of literature with technical data on Danfoss Orbital Motors

Detailed data on all Danfoss Orbital Motors can be found in our motor catalogue, which is divided into more individual subcatalogues:

- General information on Danfoss Orbital Motors: function, use, selection of orbital motor, hydraulic systems, etc.
- Technical data on small motors: OML and OMM
- Technical data on medium sized motors: OMP, OMR, OMH
- Technical data on medium sized motors: DH and DS
- Technical data on medium sized motors: OMEW
- Technical data on medium sized motors: VMP
- Technical data on medium sized motors: VMR
- Technical data on large motors: OMS, OMT and OMV
- Technical data on large motors: TMT
- Technical data on large motors: TMV

A general survey brochure on Danfoss Orbital Motors gives a quick motor reference based on power, torque, speed and capabilities.

Speed, torque and output

Speed, torque and output

The following bar diagrams, are useful for a quick selection of relevant motor size for the application. The final motor size can be determined by using the function diagram for each motor size.

- OML can be found under [function diagrams](#).
- OMM can be found under [function diagrams](#).

The function diagrams are based on actual tests on a representative number of motors from our production. The diagrams apply to a return pressure between 5 and 10 bar [75 and 150 psi] when using mineral based hydraulic oil with a viscosity of 35 mm²/s [165 SUS] and a temperature of 50°C [120°F]. For further explanation concerning how to read and use the function diagrams, please consult the paragraph "Selection of motor size" in the technical information "General" DKMH.PK.100.G2.02 520L0232.

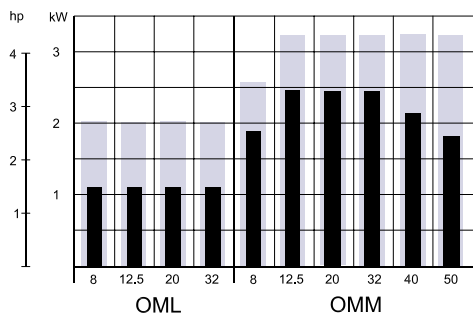
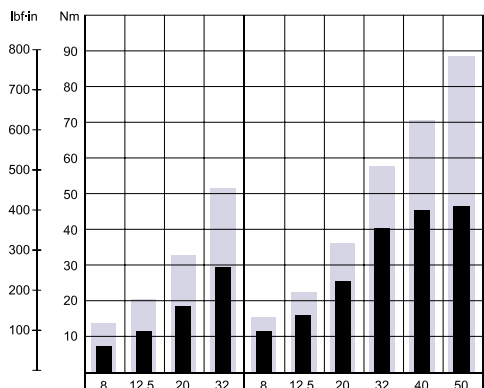
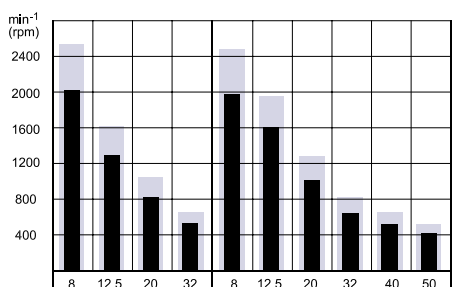

P301 016

OML

Technical Information OML and OMM Orbital Motors

Versions
OML versions

Mounting	Shaft	Port size	European version	US version	Side port version	End port version	Standard shaft seal	Drain connection	Check valve	Main type designation	Config. code
Front, 4 × M5	Cyl. 16 mm	G 1/4	X			X	X	No	Yes	OML	1
Front, 4 × 10-32 UNF	Cyl. 5/8 in	7/16 - 20 UNF		X		X	X	No	Yes	OML	2

Features available (options) :

Painted

Code numbers

Config. code	Code number - displacement (cm ³)			
	8	12.5	20	32
1	2001	2002	2003	2004
2	2021	2022	2023	2024

Ordering

Add the four digit prefix "151G" to the four digit numbers from the chart for complete code number.

Example:

151G2001 for an OML 8 with front mounting (4 × M5), cyl. 16 mm shaft and port size G 1/4.

Orders will not be accepted without the four digit prefix.

Technical Information OML and OMM Orbital Motors
Technical data
Technical data for OML with 16 mm and 5/8 in cylindrical shaft

Type		OML	OML	OML	OML
Motor Size		8	12.5	20	32
Geometric displacement	cm ³ [in ³]	8.0 [0.49]	12.5 [0.77]	20.0 [1.22]	32.0 [1.96]
Max. speed	min ⁻¹ [rpm]	cont.	2000	1280	800
		int. ¹⁾	2500	1600	1000
Max. torque	Nm [lbf·in]	cont.	7 [60]	11 [100]	18 [160]
		int. ¹⁾	13 [120]	20 [180]	32 [280]
Max. output	kW [hp]	cont.	1.1 [1.5]	1.1 [1.5]	1.1 [1.5]
		int. ¹⁾	2.0 [2.7]	2.0 [2.7]	2.0 [2.7]
Max. pressure drop	bar [psi]	cont.	70 [1020]	70 [1020]	70 [1020]
		int. ¹⁾	125 [1810]	125 [1810]	125 (85) ³ [1810] [800]3
		peak ²⁾	140 [2030]	140 [2030]	125 (85) ³ [2030] [1230]3
Max. oil flow	l/min [US gal/min]	cont.	16 [4.2]	16 [4.2]	16 [4.2]
		int. ¹⁾	20 [5.3]	20 [5.3]	20 [5.3]
Max. starting pressure with unloaded shaft	bar [psi]	4 [60]	4 [60]	4 [60]	6 [90]
Min. starting torque	at max. press. drop cont. Nm [lbf·in]	5 [45]	9 [80]	15 [135]	24 [210]
	at max. press. drop int. ¹⁾ Nm [lbf·in]	10 [90]	16 [140]	27 [240]	42 [370]
Min. speed ⁴⁾	min ⁻¹ [rpm]	50	50	50	50

Type	Max. inlet pressure		
OML 8 - 32	bar [psi]	cont.	125 [1810]
		int. ¹⁾	140 [2030]
		peak ²⁾	140 [2030]

¹⁾ Intermittent operation: the permissible values may occur for max. 10% of every minute.

²⁾ Peak load: the permissible values may occur for max. 1% of every minute.

³⁾ Max. pressure drop in applications with a large moment of inertia and frequent stops or reversings.

⁴⁾ Operation at lower speed may be slightly less smooth.

Shaft seal

Max. permissible shaft seal pressure

OML has incorporated check valves

which ensure that the pressure on the shaft seal never exceeds the pressure in the returnline.

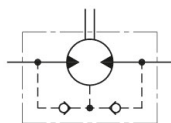

151-1316.10

Max. return pressure (max. pressure on shaft seal)

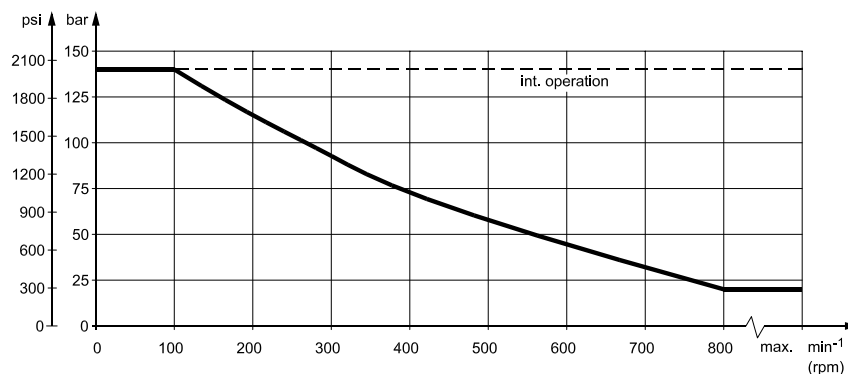

151-1671.10

Pressure Drop in Motor

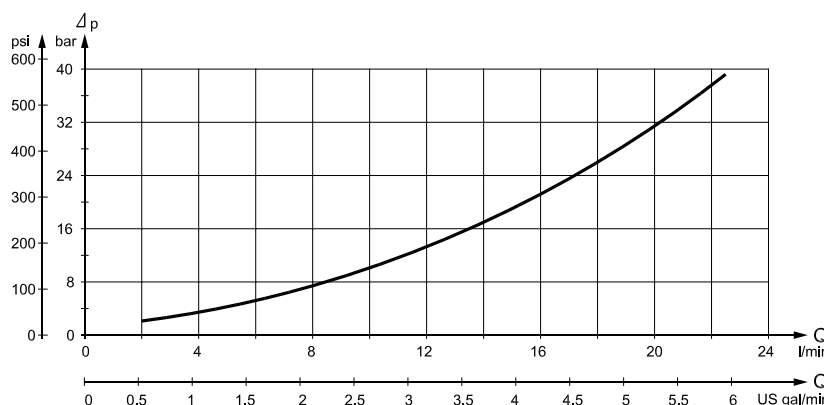

151-1415.10

The curve applies to an unloaded motor shaft and an oil viscosity of 35 mm²/s [165 SUS]

Oil flow

Direction of shaft rotation

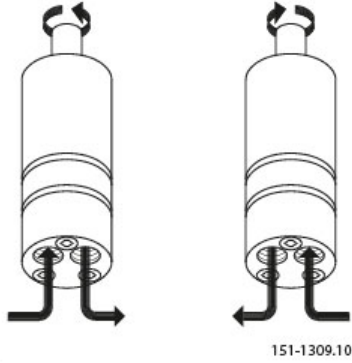

151-1309.10

Shaft load
Permissible shaft loads for OML

The permissible radial shaft load ($P_{rad.}$) is calculated from the distance (l) between the point of load and the mounting surface:

$$P_{rad.} = \frac{84500}{64.5 + l} \text{ N (l in mm; } l \leq 80)$$

$$P_{rad.} = \frac{748}{254 + l} \text{ lbf (l in inch; } l \leq 3.15)$$

The drawing shows the permissible radial load when $l = 15 \text{ mm [0.59 in]}$.

The calculated shaft load should never exceed the permissible value.

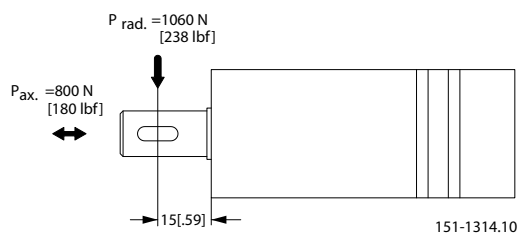

Function diagrams

Function diagrams

Explanation of function diagram use, basis and conditions can be found under [Speed, torque and output](#).

- A: Continuous range
- B: Intermittent range (max. 10% operation every minute)

Max. permissible continuous/intermittent pressure drop for the actual shaft version can be found under [Technical data](#).

Intermittent pressure drop and oil flow must not occur simultaneously.

OML 8 function diagram

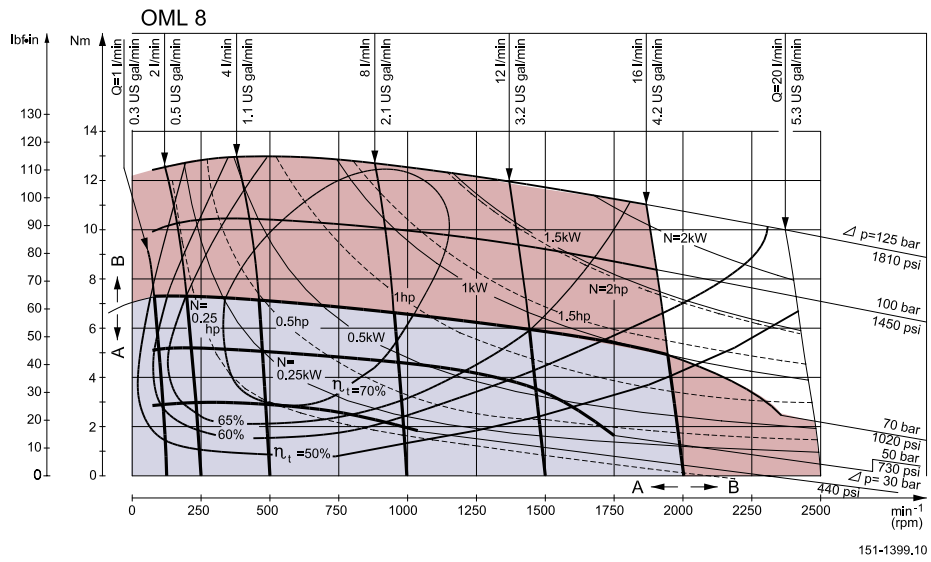

Function diagrams

OML 12.5 function diagram

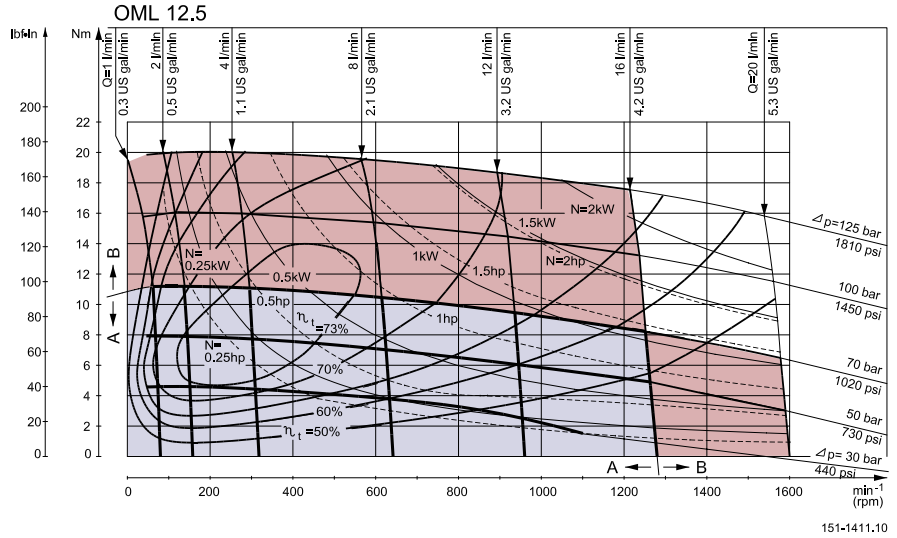

OML 20 function diagram

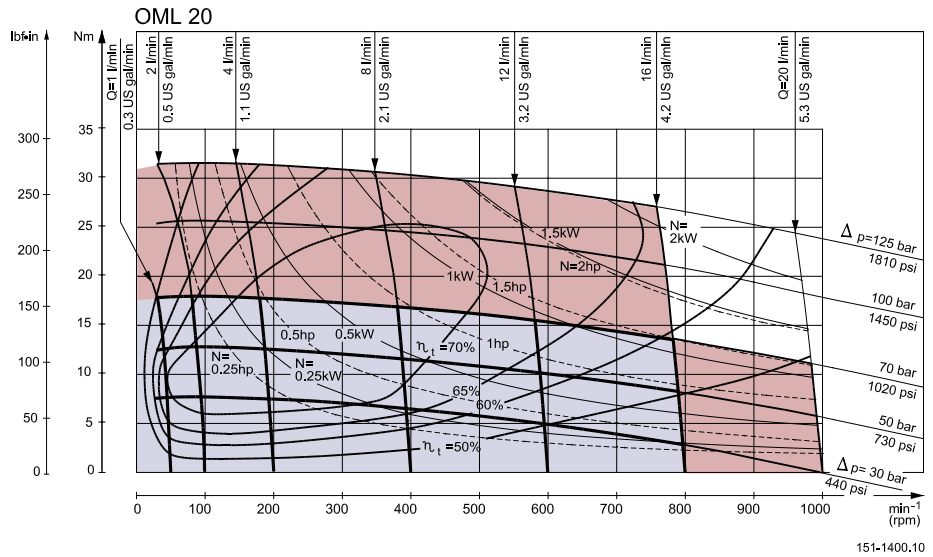

Function diagrams

OML 32 function diagram

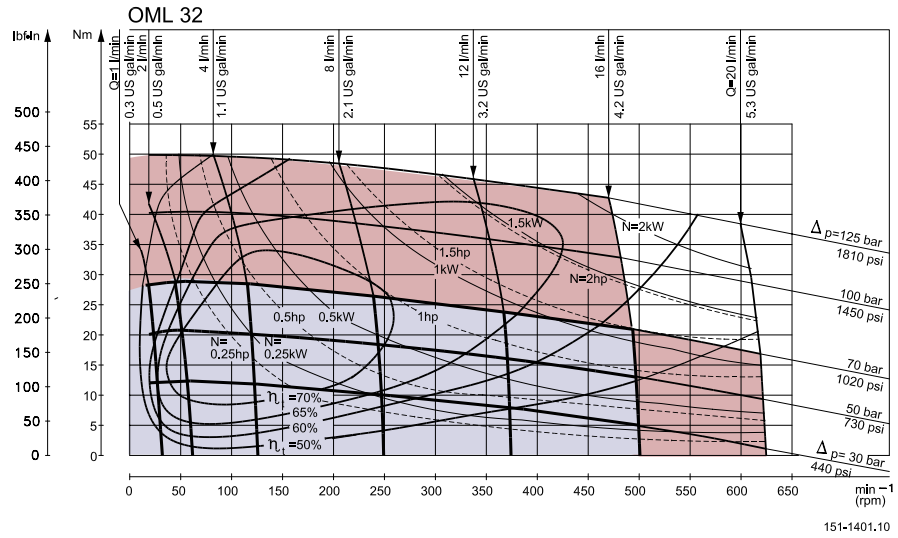

Port

Port thread versions

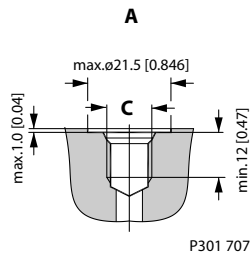

A: G main ports
C: ISO 228/1 - G1/4

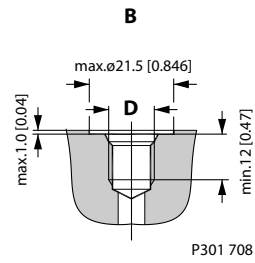

B: UNF main ports
D: 7/16 - 20 UNF
 O-ring boss port

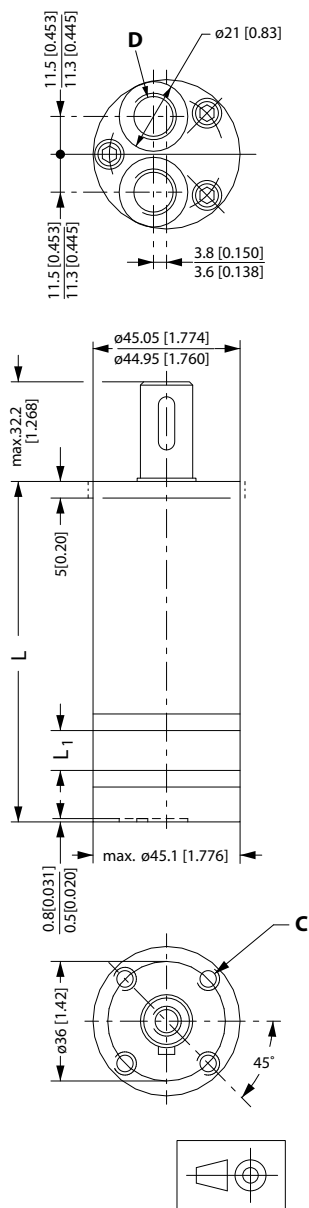
Dimensions, OML end port, European version
OML end port, European version

151-1315.10

C: M5; 15 mm [0.59 in] deep

D: G 1/4; 12 mm [0.47 in]

Weight and dimensions

Type	Length		Weight kg [lb]
	L _{max.}	L ₁ mm [in]	
OML 8	102.5 [4.04]	4.1 [0.16]	1.0 [2.2]
OML 12.5	104.8 [4.13]	6.4 [0.25]	1.0 [2.2]

Dimensions, OML end port, European version

Type	Length		Weight kg [lb]
	L _{max.}	L ₁ mm [in]	
OML 20	108.6 [4.28]	10.2 [0.40]	1.1 [2.4]
OML 32	114.7 [4.53]	16.3 [0.64]	1.2 [2.6]

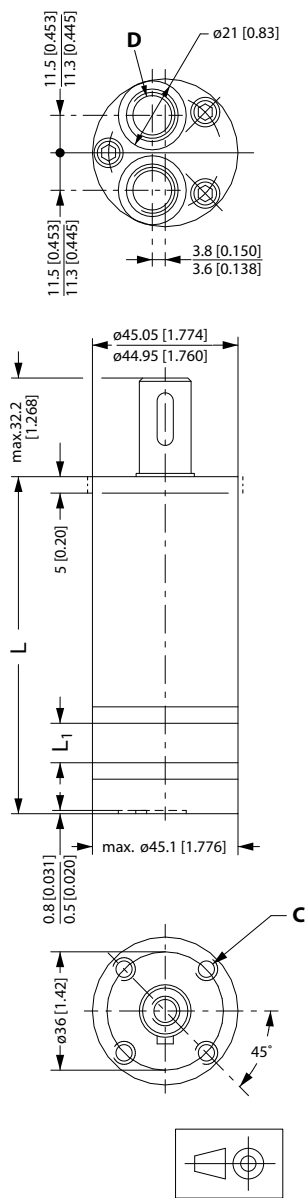
Dimensions, OML end port, US version
OML end port, US version

151-1315.10.22

C: 10 - 32 UNF; 15 mm [0.59 in] deep

D: 7/16 - UNF; 12 mm [0.47 in] deep

Weight and dimensions

Type	Length		Weight kg [lb]
	L _{max.}	L ₁ mm [in]	
OML 8	102.5 [4.04]	4.1 [0.16]	1.0 [2.2]
OML 12.5	104.8 [4.13]	6.4 [0.25]	1.0 [2.2]

Dimensions, OML end port, US version

Type	Length		Weight kg [lb]
	L _{max.}	L ₁ mm [in]	
OML 20	108.6 [4.28]	10.2 [0.40]	1.1 [2.4]
OML 32	114.7 [4.53]	16.3 [0.64]	1.2 [2.6]

OMM

Versions
OMM versions

Mounting	Shaft	Port size	European version	US version	Side port version	End port version	Standard shaft seal	Drain connection	Check valve	Main type designation	Config. code
Front; 3 × M6	Cyl. 16 mm	G 3/8	X			X	X	Yes	Yes	OMM	1
		G 3/8	X		X		X	Yes	Yes	OMM	2
Front; 3 × 1/4 - 28 UNF	Cyl. 5/8 in	9/16-18 UNF		X		X	X	Yes	Yes	OMM	3
		9/16-18 UNF		X	X		X	Yes	Yes	OMM	4
Front; 3 × M6	Splined B17×14	G 3/8	X			X	X	Yes	Yes	OMM	5
		G 3/8	X		X		X	Yes	Yes	OMM	6

Features available (options):

- Speed sensor
- Reverse rotation
- Corrosion protected
- Painted
- 2 bolt flange kit (Code no 151G0211)

Code numbers

Config. code	Code numbers, displacement (cm ³)					
	8	12.5	20	32	40	50
1	0040	0001	0002	0003	0277	0037
2	0041	0004	0005	0006	0279	0013
3	0048	0031	0032	0033	-	5032
4	0049	0034	0035	0036	-	0094
5	0046	0024	0025	0026	-	-
6	0047	0027	0028	0029	0294	-

Ordering

Add the four digit prefix "151G" to the four digit numbers from the chart for complete code number.

Example:

151G0035 for an OMM 20 with front mounting (3 × 1/4 - 28 UNF), cyl. 5/8 in shaft and port size 9/16 - 18 UNF.

Orders will not be accepted without the four digit prefix.

Technical data
Technical data for OMM with 16 mm and 5/8 in cylindrical shaft

Type			OMM	OMM	OMM	OMM	OMM	OMM
Motor size			8	12.5	20	32	40	50
Geometric displacement	cm ³ [in ³]		8.2 [0.50]	12.5 [0.77]	19.9 [1.22]	31.6 [1.93]	39.8 [2.43]	50 [3.08]
Max. speed	min ⁻¹	cont.	1950	1550	1000	630	500	400
	[rpm]	int. ¹⁾	2450	1940	1250	800	630	500
Max. torque	Nm [lbf·in]	cont.	11 [95]	16 [140]	25 [220]	40 [350]	45 [400]	46 [410]
		int. ¹⁾	15 [135]	23 [200]	35 [310]	57 [500]	70 [620]	88 [780]
Max. output	kW [hp]	cont.	1.8 [2.4]	2.4 [3.2]	2.4 [3.2]	2.4 [3.2]	2.2 [3.0]	1.8 [2.4]
		int. ¹⁾	2.6 [3.5]	3.2 [4.3]	3.2 [4.3]	3.2 [4.3]	3.2 [4.3]	3.2 [4.3]
Max. pressure drop	bar [psi]	cont.	100 [1450]	100 [1450]	100 [1450]	100 [1450]	90 [1310]	70 [1020]
		int. ¹⁾	140 [2030]	140 [2030]	140 [2030]	140 [2030]	140 [2030]	140 [2030]
		peak ²⁾	200 [2900]	200 [2900]	200 [2900]	160 [2320]	160 [2320]	160 [2320]
Max. oil flow	l/min [US gal/min]	cont.	16 [4.2]	20 [5.3]	20 [5.3]	20 [5.3]	20 [5.3]	20 [5.3]
		int. ¹⁾	20 [5.3]	25 [6.6]	25 [6.6]	25 [6.6]	25 [6.6]	25 [6.6]
Max. starting pressure with unloaded shaft	bar [psi]		4 [60]	4 [60]	4 [60]	4 [60]	4 [60]	4 [60]
Min. starting torque	at max. press. drop cont. Nm [lbf·in]		7 [60]	12 [105]	21 [185]	34 [300]	38 [335]	41 [365]
	at max. press. drop int. ¹⁾ Nm [lbf·in]		10 [90]	17 [150]	29 [255]	48 [425]	62 [550]	79 [700]
Min. speed ³⁾	min ⁻¹ [rpm]		50	40	30	30	30	30

Type	Max. inlet pressure		
OMM 8 - 50	bar [psi]	cont.	140 [2030]
		int. ¹⁾	175 [2538]
		peak ²⁾	225 [3260]

¹⁾ Intermittent operation: the permissible values may occur for max. 10% of every minute.

²⁾ Peak load: the permissible values may occur for max. 1% of every minute.

³⁾ Operation by lower speeds may be slightly less smooth.

Shaft seal

Max. permissible shaft seal pressure

OMM with check valves and without use of drain connection:

OMM with check valves and drain connection:

The pressure on the shaft seal never exceeds the pressure in the return line.

The shaft seal pressure equals the pressure on the drain line.

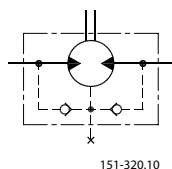

Max. return pressure without drain line or max. pressure in drain line

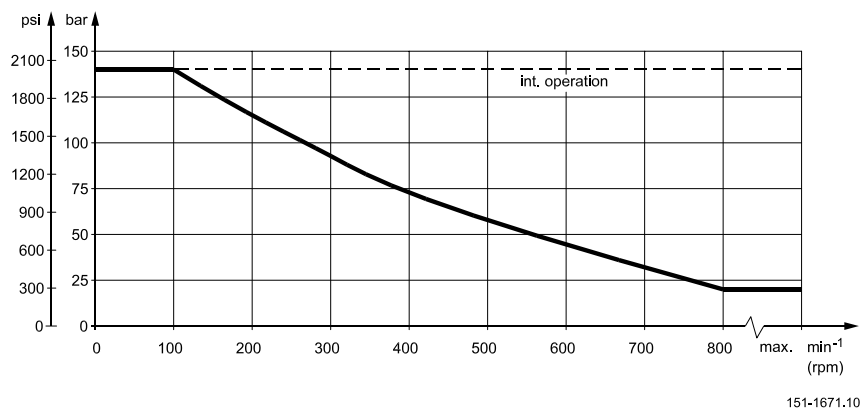

Pressure drop in motor

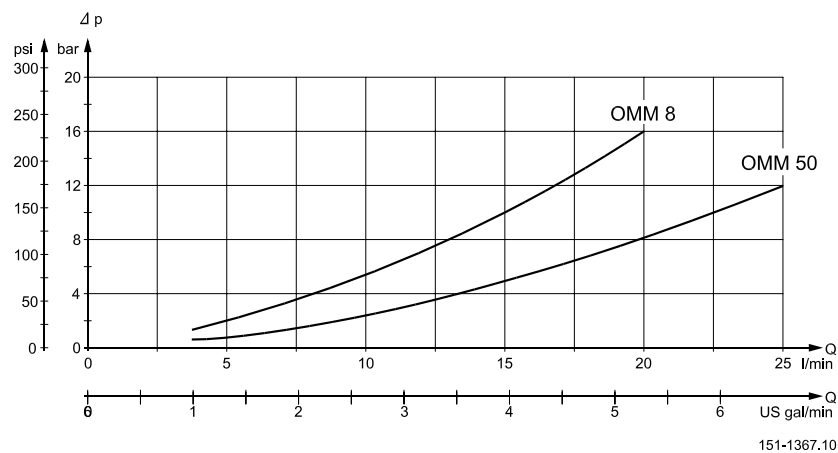

The curve applies to an unloaded motor shaft and an oil viscosity of 35 mm²/s [165 SUS]

Oil flow

Direction of shaft rotation

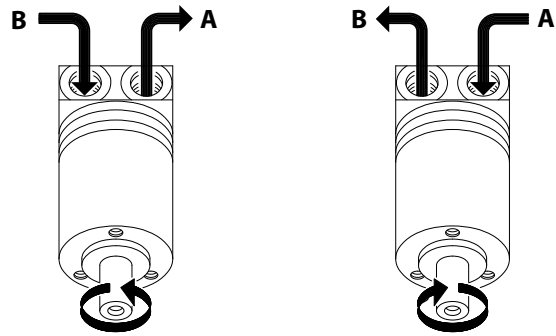

P301 008

Shaft load

Permissible shaft loads for OMM

The permissible radial shaft load ($P_{rad.}$) is calculated from the distance (l) between the point of load and the mounting surface:

$$P_{rad.} = \frac{130400}{61.5 + l} \text{ N (l in mm; } l \leq 80 \text{ mm)}$$

$$P_{rad.} = \frac{748}{2.54 + l} \text{ lbf (l in inch; } l \leq 3.15 \text{ in)}$$

The drawing shows the permissible radial load when $l = 20 \text{ mm [0.79 in]}$.

The calculated shaft load should never exceed the permissible value.

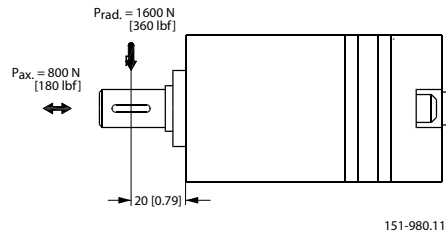

151-980.11

Function diagrams

Function diagrams

Explanation of function diagram use, basis and conditions can be found under [Speed, torque and output](#).

- Light grey: Continuous range
- Light red: Intermittent range (max. 10% operation every minute)

Max. permissible continuous/intermittent pressure drop for the actual shaft version can be found under [Technical data](#).

Intermittent pressure drop and oil flow must not occur simultaneously.

OMM 8 function diagram

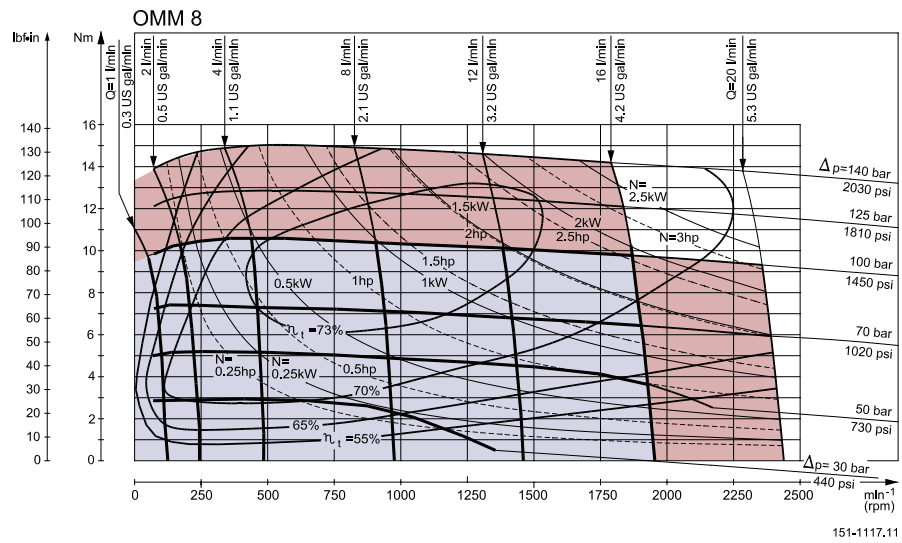

OMM 12.5 function diagram

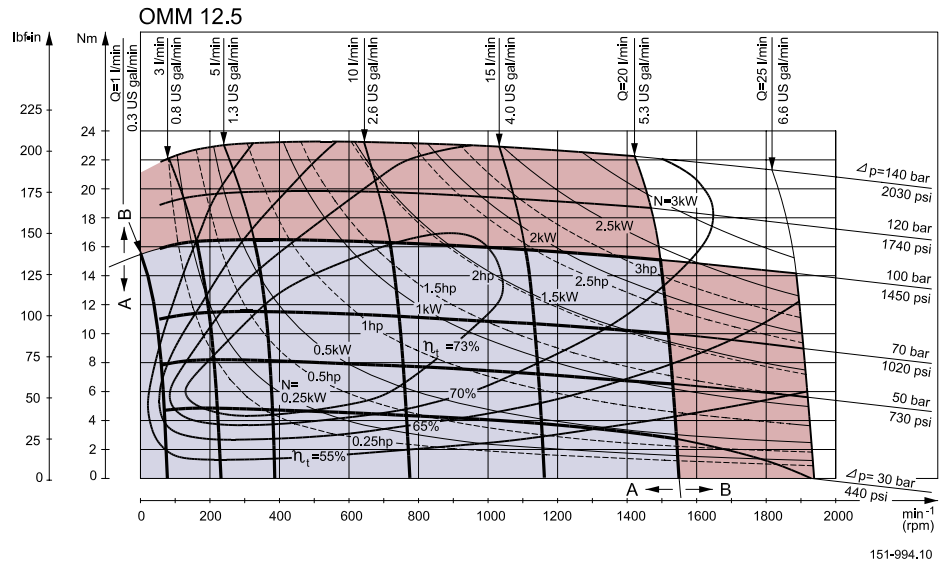

Function diagrams

OMM 20 function diagram

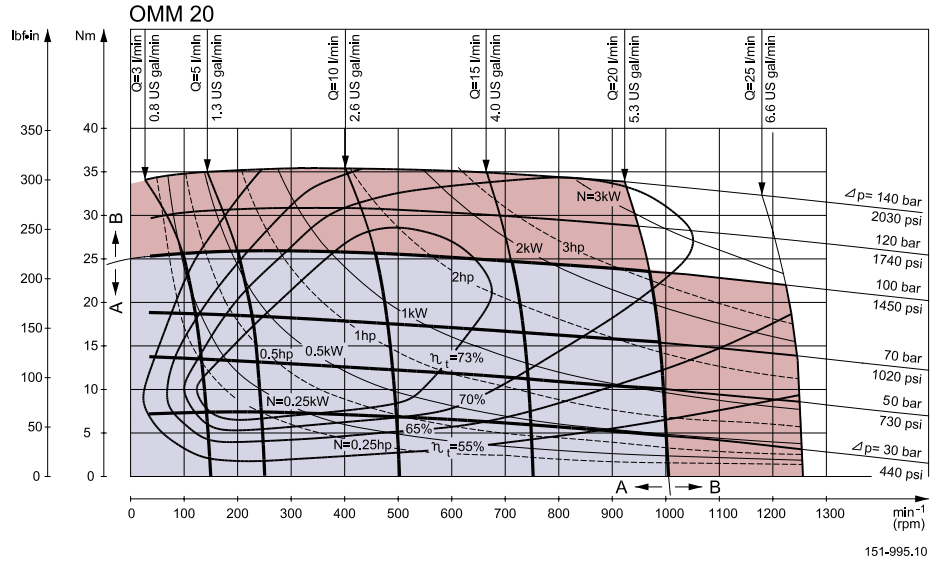

OMM 32 function diagram

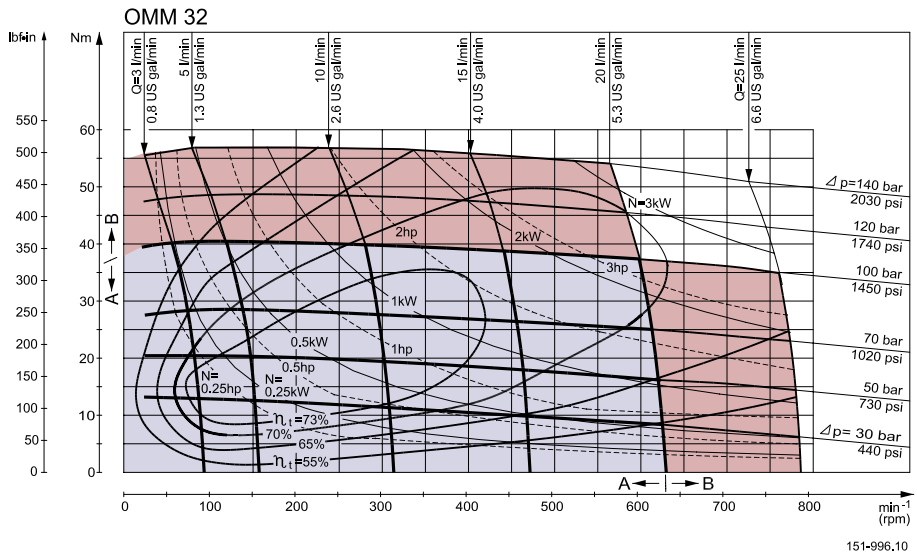

Function diagrams

OMM 50 function diagram

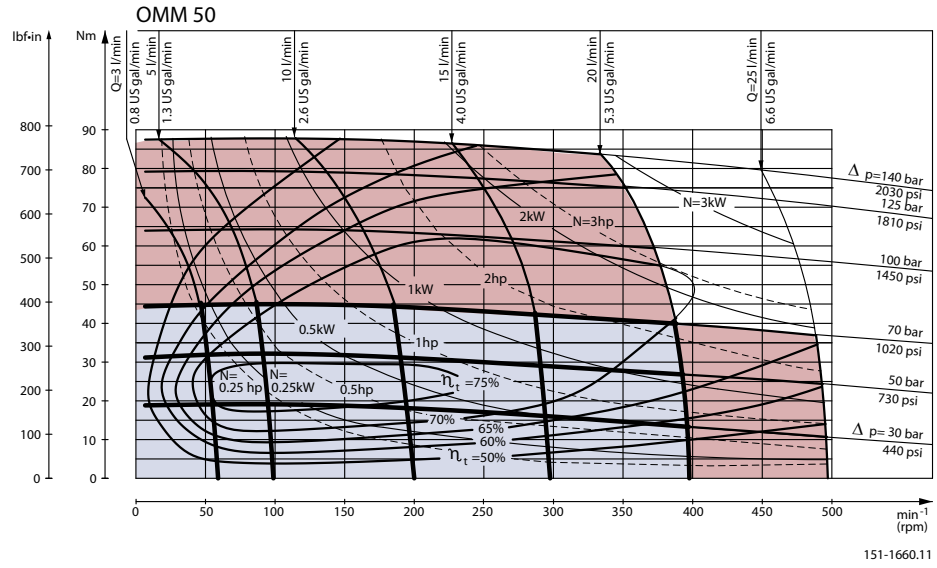

151-1660.11

Shaft

Shaft version

A: Cylindrical shaft 16 mm [0.63 in]
D: Parallel key
 A5 • 5 • 16
 DIN 6885

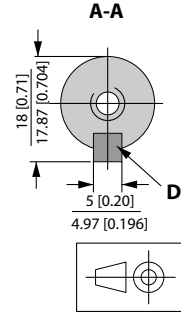
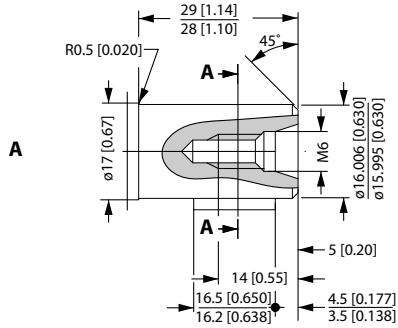

P301 704

US version

B: Cylindrical shaft
 5/8 in
E: Parallel key
 3/16 • 3/16 • 3/4 in
 B.S. 46

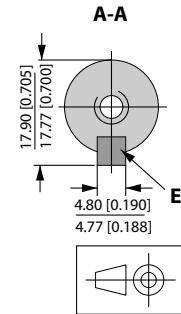
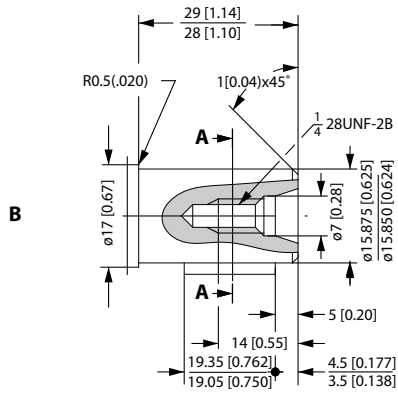

P301 705

C: Involute splined shaft
 B17 • 14, DIN 5482
 Measurement 19.641 ± 0.04 mm
 over 3 mm pins deviates from
 DIN 5482

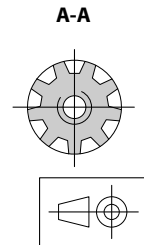
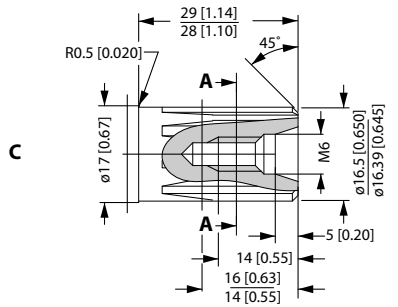

P301 706

Port

Port thread versions

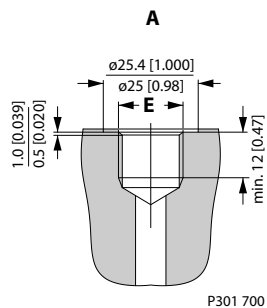

A: G main ports
E: ISO 228/1 - G3/8

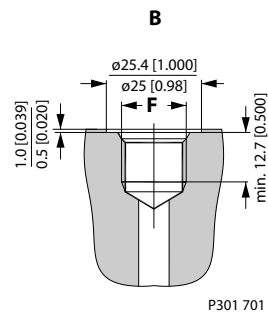

B: UNF main ports
F: 9/16 - 18 UNF O-ring boss port

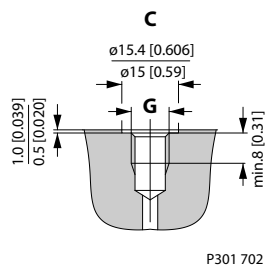

C: G drain ports
G: ISO 228/1 - G1/8

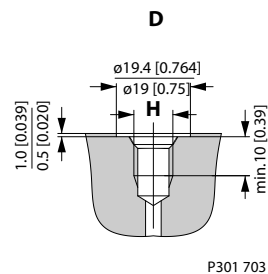

D: UNF drain ports
H: 3/8 - 24 UNF O-ring port

Dimensions, OMM end port, European version

OMM end port, European version

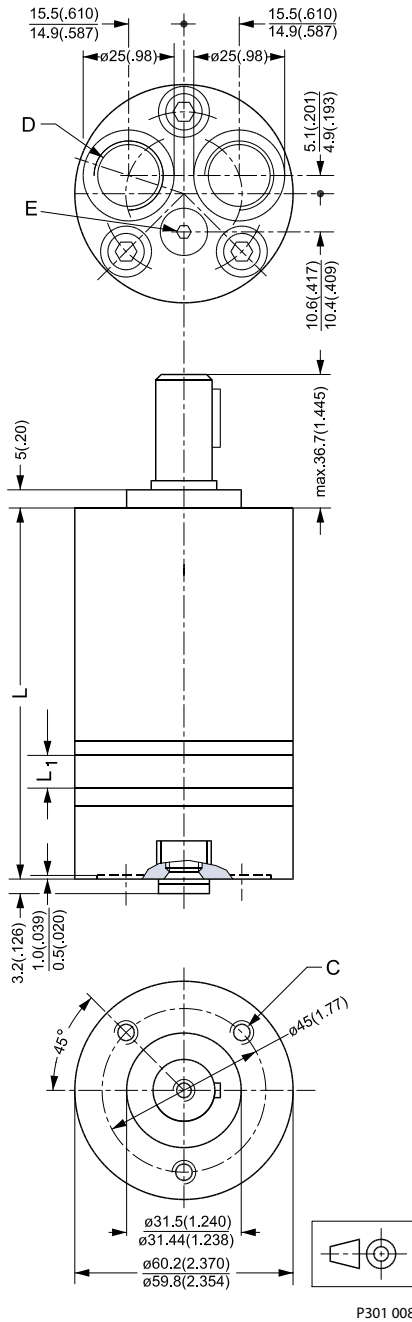

- C: M6; 10 mm [0.39 in] deep
- D: G 3/8; 12 mm [0.47 in] deep
- E: Drain connection G 1/8; 8 mm [0.39 in] deep

Dimensions, OMM end port, European version
Weight and dimensions

Type	Length		Weight kg [lb]
	L max.	L1 mm [in]	
OMM 8	104.0 [4.09]	3.5 [0.14]	1.9 [4.2]
OMM 12.5	106.0 [4.17]	5.5 [0.22]	2.0 [4.4]
OMM 20	109.0 [4.29]	8.5 [0.33]	2.1 [4.6]
OMM 32	114.0 [4.49]	13.5 [0.53]	2.2 [4.8]
OMM 40	118.0 [4.65]	17.0 [0.67]	2.3 [5.1]
OMM 50	122.0 [4.80]	21.5 [0.85]	2.4 [5.3]

Dimensions, OMM end port, US version

OMM end port, US version

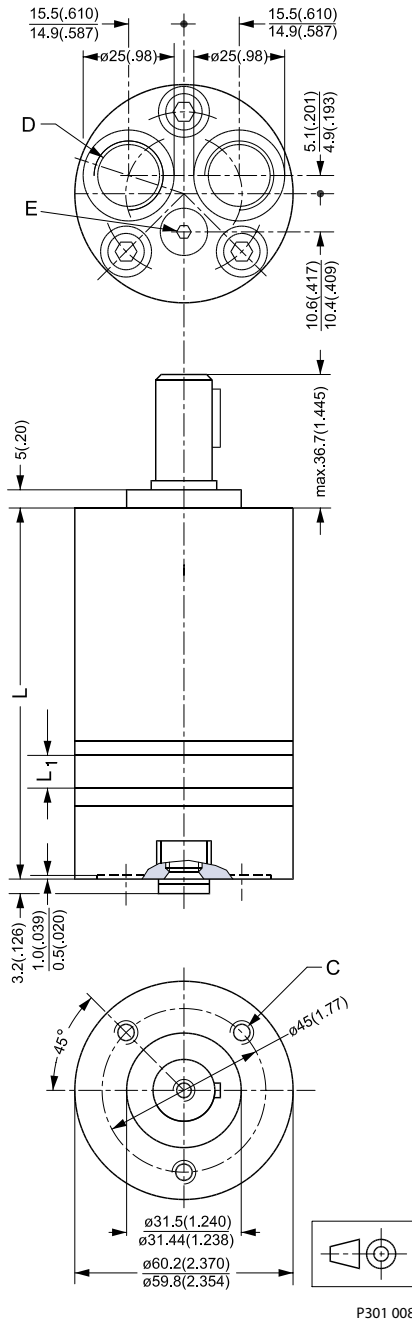

C: 1/4 - 28 UNF - 2B; min. 10 mm [0.39 in] deep

D: 9/16 - 18 UNF; 12 mm [0.47 in] deep O-ring boss port

E: 3/8 - 24 UNF; 8 mm [0.39 in] deep O-ring port

Dimensions, OMM end port, US version***Weight and dimensions***

Type	Length		Weight kg [lb]
	L max.	L1 mm [in]	
OMM 8	104.0 [4.09]	3.5 [0.14]	1.9 [4.2]
OMM 12.5	106.0 [4.17]	5.5 [0.22]	2.0 [4.4]
OMM 20	109.0 [4.29]	8.5 [0.33]	2.1 [4.6]
OMM 32	114.0 [4.49]	13.5 [0.53]	2.2 [4.8]
OMM 50	122.0 [4.80]	21.5 [0.85]	2.4 [5.3]

Dimensions, OMM side port, European version

OMM side port, European version

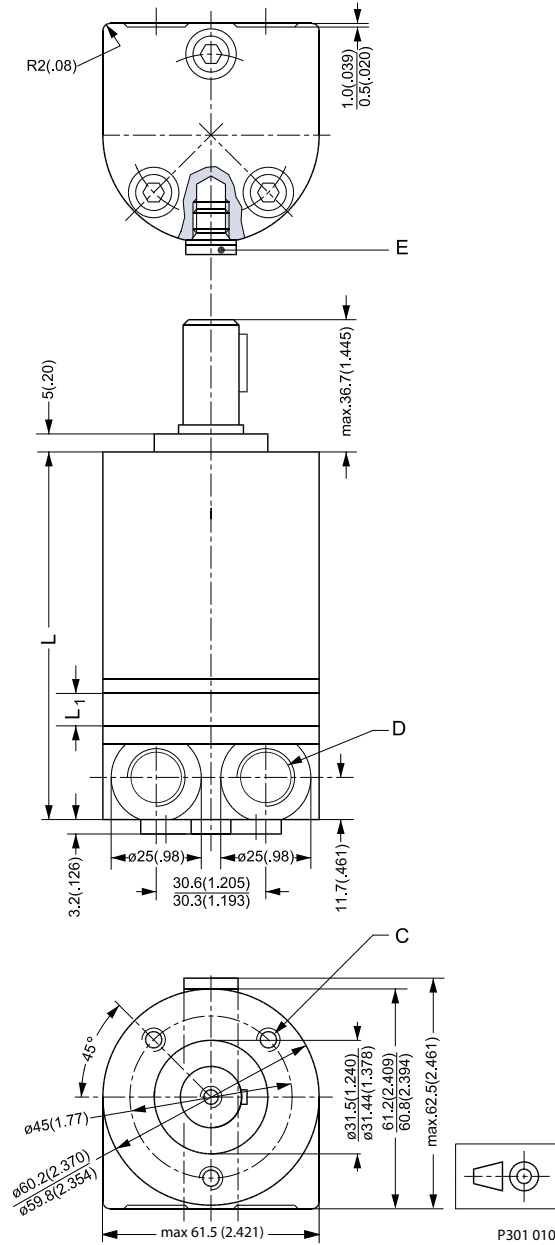

- C: M6; 10 mm [0.39 in] deep
- D: G 3/8; 12 mm [0.47 in] deep
- E: Drain connection G 1/8; 8 mm [0.39 in] deep

Dimensions, OMM side port, European version
Weight and dimensions

Type	Length		Weight kg [lb]
	L max.	L1 mm [in]	
OMM 8	104.0 [4.09]	3.5 [0.14]	1.9 [4.2]
OMM 12.5	106.0 [4.17]	5.5 [0.22]	2.0 [4.4]
OMM 20	109.0 [4.29]	8.5 [0.33]	2.1 [4.6]
OMM 32	114.0 [4.49]	13.5 [0.53]	2.2 [4.8]
OMM 40	118.0 [4.65]	17.0 [0.67]	2.3 [5.1]
OMM 50	122.0 [4.80]	21.5 [0.85]	2.4 [5.3]

Dimensions, OMM side port, US version

OMM side port, US version

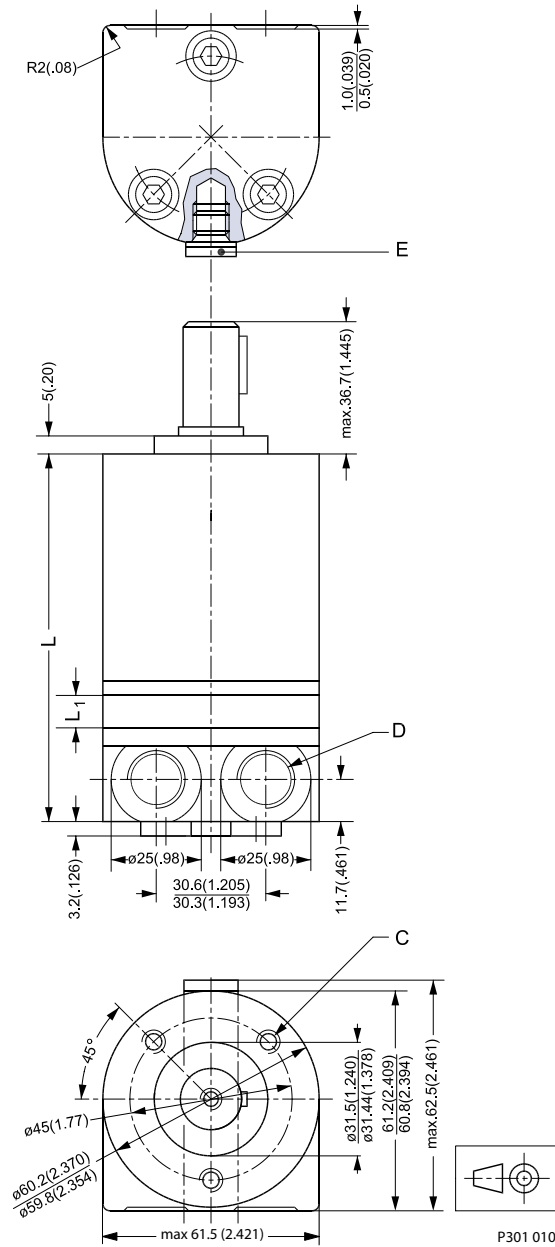

C: 1/4 - 28 UNF - 2B; min. 10 mm [0.39 in] deep

D: 9/16 - 18 UNF ; 12 mm [0.47 in] deep

E: 3/8 - 24 UNF ; 8 mm [0.39 in] deep

Dimensions, OMM side port, US version
Weight and dimensions

Type	Length		Weight kg [lb]
	L max.	L1 mm [in]	
OMM 8	104.0 [4.09]	3.5 [0.14]	1.9 [4.2]
OMM 12.5	106.0 [4.17]	5.5 [0.22]	2.0 [4.4]
OMM 20	109.0 [4.29]	8.5 [0.33]	2.1 [4.6]
OMM 32	114.0 [4.49]	13.5 [0.53]	2.2 [4.8]
OMM 50	122.0 [4.80]	21.5 [0.85]	2.4 [5.3]

Accessories

2 bolt flange kit, code no. 151G0211

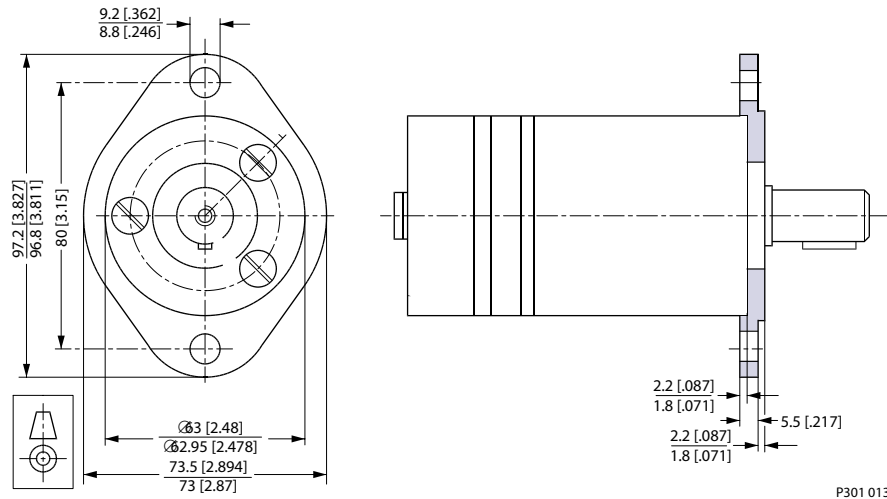

P301 013

Hydraulic systems

Installation of the Danfoss Orbital Motors

About the design

- To ensure efficient operation all hydraulic components must be installed according to their individual instructions.
- The pump line must include a manometer connection.
- To ensure designed contact and minimise the tension all mounting flanges must be flate.

Hydraulic lines must be fitted correctly to prevent air entrapment.

About the assembly

- Follow the mounting instructions printed on the inside of the cardboard box.
- To prevent contamination, do not dismantle the plastic plugs from the connection ports until the fittings are ready to be assembled.
- Check that there is full face contact between the motor mounting flange and the mating part.
- Do not force the motor into place when tightening the mounting screws.
- Avoid unsuitable sealing material on fittings such as pack twine, teflon and others.
- Use only bonded seals, O-rings, steel washers and the like.
- When tightening the fittings never use a torque higher than the max. tightening torque stated in the instructions.
- Make sure that the cleanliness of the oil used is better than 20/16 (ISO 4406). Always use a filter for oil refilling.

Starting up and running in the hydraulic system

- Through a small-meshed filter fill up the tank with oil to the upper oil level mark.
- Start the drive engine, and if possible, let it work at its lowest speed. If the motor is provided with bleed screws, keep these open until the emerging oil is non-foaming.
- Check that all components are correctly connected (pump following the right direction of rotation etc.).
- In load-sensing systems, also make sure that the signal lines are bled.
- Indications of air in the hydraulic system:
 - foam in the tank
 - jerky movements of motor and cylinder
 - noise
- If so required, refill with oil.
- Connect the system to a separate tank that includes a filter (fineness max. 10 µm) with twice the capacity of the max. oil flow. Let the entire system run without load (no pressure) for about 30 minutes.
- Do not load the system until it is all bled and clean.
- Check the tightness of the system and make sure that its performance is satisfactory.
- Change the oil filter, and if so required, refill with oil.

Operation

- Do not expose the motor to pressures, pressure drops and speeds above the max. values stated in the catalogue.
- Filter the oil to ensure that the contamination level 20/16 (ISO 4406) or better.

Hydraulic systems

Maintenance

- When working with hydraulic systems, the main criteria of operating safety and endurance is careful maintenance.
- Always renew and replace oil, oil filters and air filters according to the instructions given by the respective manufacturers.
- Regularly check the condition of the oil.
- Frequently check system tightness and oil level.



Products we offer:

- Bent Axis Motors
- Closed Circuit Axial Piston Pumps and Motors
- Displays
- Electrohydraulic Power Steering
- Electrohydraulics
- Hydraulic Power Steering
- Integrated Systems
- Joysticks and Control Handles
- Microcontrollers and Software
- Open Circuit Axial Piston Pumps
- Orbital Motors
- PLUS+1® GUIDE
- Proportional Valves
- Sensors
- Steering
- Transit Mixer Drives

Danfoss Power Solutions is a global manufacturer and supplier of high-quality hydraulic and electronic components. We specialize in providing state-of-the-art technology and solutions that excel in the harsh operating conditions of the mobile off-highway market. Building on our extensive applications expertise, we work closely with our customers to ensure exceptional performance for a broad range of off-highway vehicles.

We help OEMs around the world speed up system development, reduce costs and bring vehicles to market faster.

Danfoss – Your Strongest Partner in Mobile Hydraulics.

Go to www.powersolutions.danfoss.com for further product information.

Wherever off-highway vehicles are at work, so is Danfoss.

We offer expert worldwide support for our customers, ensuring the best possible solutions for outstanding performance. And with an extensive network of Global Service Partners, we also provide comprehensive global service for all of our components.

Please contact the Danfoss Power Solution representative nearest you.

Comatrol

www.comatrol.com

Schwarz Müller-Inverter

www.schwarzmueller-inverter.com

Turolla

www.turollaocg.com

Valmova

www.valmova.com

Hydro-Gear

www.hydro-gear.com

Daikin-Sauer-Danfoss

www.daikin-sauer-danfoss.com

Local address:

Danfoss Power Solutions US Company
2800 East 13th Street
Ames, IA 50010, USA
Phone: +1 515 239 6000

Danfoss Power Solutions GmbH & Co. OHG
Krokamp 35
D-24539 Neumünster, Germany
Phone: +49 4321 871 0

Danfoss Power Solutions ApS
Nordborgvej 81
DK-6430 Nordborg, Denmark
Phone: +45 7488 2222

Danfoss Power Solutions (Shanghai) Co. Ltd.
Building #22, No. 1000 Jin Hai Rd
Jin Qiao, Pudong New District
Shanghai, China 201206
Phone: +86 21 3418 5200

Danfoss can accept no responsibility for possible errors in catalogues, brochures and other printed material. Danfoss reserves the right to alter its products without notice. This also applies to products already on order provided that such alterations can be made without subsequential changes being necessary in specifications already agreed. All trademarks in this material are property of the respective companies. Danfoss and the Danfoss logotype are trademarks of Danfoss A/S. All rights reserved.